

HPX
LIGHT



LAMPS CATALOG

Focused Innovation.

WelchAlllyn®

TABLE OF CONTENTS

Introduction	1
HPX Engineering & Industry Leadership	2
HPX Miniature Lamp Types	2
Miniature Halogen Lamps— Optical Characteristics	3
Miniature Halogen Lamps— Electrical Characteristics	5
Miniature Halogen Lamps— Mechanical Characteristics	6
Miniature Halogen Lamps— Environmental & Operational Conditions	7
High-Impact Illumination Designed for High-Performance Products	8
Miniature Halogen Lamps— General-Illumination Lamps, Wire Terminals	8
Miniature Halogen Lamps— General-Illumination Lamps, Based Lamps	11
Miniature Halogen Lamps— Reflectorized Lamp Types, Parabolic & Elliptical	11
Halogen Lamps— Application Notes, Enhanced UV Miniature Lamps	16
Halogen Lamps— Application Notes, Enhanced UV Miniature Lamps	16
Medical & Dental Instruments.....	18
Miniature Halogen Lamps— Medical & Dental Instrument Lamps	18
Analytical Instruments	19
Miniature Halogen Lamps	20
Miniature Halogen Lamps— Lamp Base.....	21

With over 80 years of delivering high-performance lighting solutions to customers worldwide, Welch Allyn continues this tradition with its HPX technology.

Our enviable reputation for engineering lighting solutions that exceed industry performance standards, while providing the consistent light output that our customers demand, continues to drive our HPX technology. We also know that the products you design must not only meet your customers' requirements, they must also set themselves apart from your customers' competition. HPX lamps will accomplish this for you...and much more.

HPX products give you the design flexibility for use in a wide variety of applications. When properly specified and applied, they will reliably provide excellent and predictable product performance.

As with any advanced technology, it is important that you understand key application techniques. This HPX Technical Operation Guide has been arranged to help you easily find the information you need for your specific application. It summarizes important lamp configuration, performance data and technical information that will help get you started.

By following the specifications given in this guide, you (and your customers) will be rewarded with years of dependable, troublefree service from your new HPX products. Please read these instructions thoroughly before use.

For more detailed information on specific HPX lamp solutions, please contact your Welch Allyn representative.

HPX— Precision Lighting Solutions Engineered for Your Products.

HPX ENGINEERING & INDUSTRY LEADERSHIP

You're creating innovative products that require advanced and high-performance lighting systems. The final solution must meet the most demanding specifications...yours. To ensure that each of your lighting applications meets with success, Welch Allyn offers you complete design, engineering and manufacturing services for your specific project.

Lighting Products Development Team

When designing a custom lighting system for your product, you'll have direct access to our experienced team of lighting engineers—all of whom have years of experience designing and manufacturing miniature lamps to strict electro-optical requirements. These industry experts can advise you on the best possible solutions to any of your complex lighting needs—and help you save valuable design and production time in the process.

Consistent, Reliable Light Output Performance

As is the case with all HPX products—from lamps and lenses to complete modules—our custom-built systems are manufactured to tolerances that will exceed industry standards and provide the consistent light output you demand.

Industry standards typically specify lamps with current draw tolerances of $\pm 10\%$. This means that light output can vary anywhere from 30%–40%. HPX lamps typically have current draw tolerances of $\pm 5\%$. This, in turn, reduces the possible light variance to just 15%–20%, giving you higher-quality, uniform illumination.

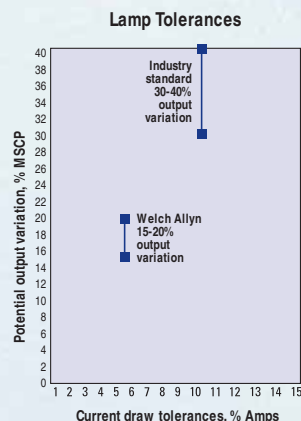

Our strict standards also help to ensure that every HPX lamp, subassembly and module operate with identical performance characteristics. This saves you and your customer the time and money required to recalibrate or readjust the lighting system each time a lamp is replaced.

Maximum Light Output

Our unique Precision Optical Basing technique is applied to all of our custom-built HPX lamps. This guarantees that the lamp's vital optics are on center with the lamp's base to within ± 0.127 mm therefore guaranteeing that the lamp will work to its full potential with any fixed external optics, lenses, reflectors or modules. What's more, our Precision Optical Basing technique also works with lensed-end lamps, ensuring consistent spot projection from lamp to lamp.

Superior Light Maintenance

HPX lamps are among the industry's best at maintaining high light output levels over the life of the lamp. What's more, the life of an HPX lamp is considerably longer than that of most competitive high color temperature lamps.

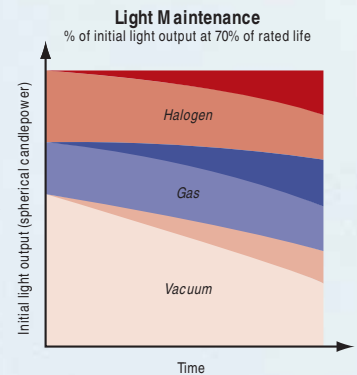

Precision Performance Guarantee

Welch Allyn has developed several proprietary design, tight-tolerance manufacturing and quality-checking processes for all of our lamps. These methods are also applied to each of our custom-built lighting systems. By demanding superior performance from each HPX lamp, we help ensure the reliability and outstanding performance of your products—and enhance their overall value to your customers. Our goal is 100% quality, and our Precision Performance Guarantee backs it: if an HPX lamp does not perform to your specifications under normal operating conditions, we will replace it free of charge.*



HPX MINIATURE LAMP TYPES

High performance, high quality and long life are why HPX lamps deliver superior light maintenance. To help meet your specific lighting requirements, HPX lamps are easily customized. Our vacuum and gas-filled lamps are especially well suited for short duty cycles.

Halogen Lamps

The halogen lamp achieves light output through the incandescence of a tungsten filament. Similar in construction to the gas-filled lamp, halogen lamps contain an inert gas combined with an active halogen compound. The inert gas suppresses tungsten evaporation, while the halogen chemically combines with the tungsten evaporated from the filament, preventing deposition of the tungsten on the lamp wall. Through a chemical regenerative cycle, the tungsten is redeposited on the filament and halogen is then freed from the tungsten to repeat its active role.

For the halogen regenerative cycle to work, the lamp must be maintained at a certain temperature. For higher wattage halogen lamps this critical temperature is approximately 250°C . For some of our miniature and sub-miniature halogen lamps, the critical temperature is less than 250°C . This is due to our unique gas chemistries and lamp designs.

*For details, see our standard terms and conditions of sale.

It is recommended that you check with Welch Allyn engineers for the critical temperature for the lamp you select. These lamps are very application dependent, with duty cycle and heat sinking being prime considerations.

Halogen Advantages

- Highest color temperature
- Highest luminous efficacy
- Superior maintenance and life as a result of the halogen regenerative cycle
- Color temperatures typically range from 2,700°K to 3,350°K with current draw less than 3.0 amperes
- Surface temperature is similar to comparable gas-filled lamps (halogen lamps do run slightly higher than a vacuum lamp of comparable size and wattage)
- Halogen lamps can be readily designed to meet most lamp application requirements (despite the limitation on duty cycle and heat sinking)

Gas-Filled Lamps

The gas-filled lamp is similar in appearance to the vacuum lamp. There are, however, significant differences in its construction, operation and performance. Gas-filled lamps achieve light output through the incandescence of a tungsten filament in a pressurized, inert gas atmosphere that suppresses the evaporation of tungsten.

Gas-Filled Advantages

- Lamp design offers higher color temperatures
- Higher luminous efficacy
- Better light maintenance and longer life
- Not adversely affected by short duty cycles or heat sinking
- Color temperatures typically range from 2,600°K to 3,200°K, with current draw less than 2.0 amperes

Surface temperatures run slightly higher than vacuum lamps of comparable size and wattage due to the internal gas atmospheres and higher allowable current draw. Light output will decrease somewhat over the life of the lamp. However, this loss of maintenance is slight compared to a corresponding vacuum lamp. These characteristics offer distinct application advantages—and gas-filled lamps can be easily customized into a unique design.

Vacuum

Vacuum lamps achieve light output through the incandescence of a tungsten filament in a vacuum environment within the lamp glass envelope. They are a good general-purpose light source where lower luminous efficacy is acceptable and are not adversely affected by short duty cycles. Color temperatures typically range from 2,400°K to 2,700°K and current draw is less than .8 amperes.

Since these lamps lack an internal gas atmosphere, the surface temperature will be cooler and luminous stability is more easily achieved.

Light output decreases over the life of the lamp due to tungsten evaporation and its deposition on the interior glass surface, darkening the lamp wall over time. The rate of darkening increases as the color temperature increases, and is typically referred to as the loss of maintenance—the ability of the lamp to maintain its initial level of light output. Lamp failure is ultimately caused by the evaporation of tungsten from the filament and subsequent thinning of the filament wire to the point of burn through. Another form of failure occurs when the level of light output diminishes to the point at which it is insufficient for the application.

Figure 1: Summary of Lamp Types & Typical Performance Characteristics

	Vacuum	Gas-Filled Krypton	Gas-Filled Xenon	Halogen
Color Temp. (°K)	2,400–2,700	2,600–3,200	2,600–3,200	2,700–3,350
Maintenance	30%–50%	75%	85%	85%–98%
Relative Output	100%	120%	150%	200%

MINIATURE HALOGEN LAMPS—OPTICAL CHARACTERISTICS

Maintenance

Maintenance is the ability of a lamp to maintain its initial level of light output. It is often expressed as a percentage of the lamp’s original output at 70% of the rated lamp life. Maintenance is an important consideration in selecting a lamp because, while the lamp may still light, its light output could degrade to a point at which there is insufficient energy for the application. Figure 2 shows the relationship of the three lamp types to initial light output levels and maintenance.

Figure 2: Light Maintenance

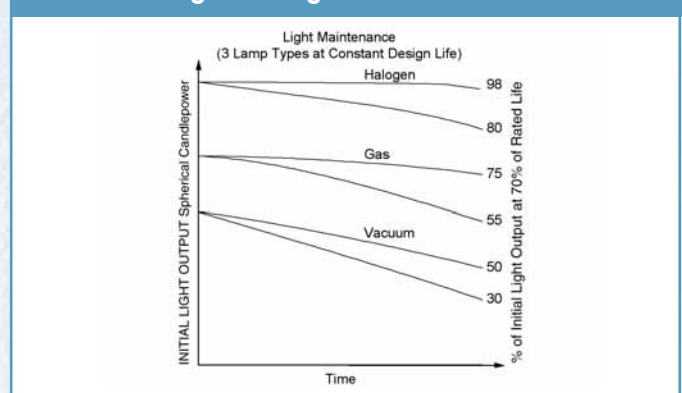

Our halogen lamps not only have a higher output at a given wattage, they also have superior maintenance. Gas-filled lamps have superior maintenance to vacuum lamps and in some applications, where there is a short duty cycle or significant heat sinking, they are superior to halogen lamps.

Light Output and Efficacy

Light output is commonly measured and expressed in terms of mean spherical candlepower (MSCP). This measurement is calculated by placing an unbased, wire terminal lamp in an integrating sphere (calibration is traceable to the National Institute of Standards and Technology) and powered at rated voltage. The MSCP value is a photopic measure and may be converted to another commonly used measure—lumens—through the following formula:

$$\text{Lumens} = \text{MSCP} \times 4\pi$$

MSCP—and therefore lumens—is a function of the wattage, color temperature and filament coil configuration. Lamp efficacy increases dramatically with increased color temperature. Figure 3 illustrates this relationship. The efficacy of a lamp is its luminous output per watt expressed by the following formula:

$$\text{Lamp Efficacy} = \text{Lumens} \div \text{Watts}$$

Figure 3: Efficacy vs. Color Temperature

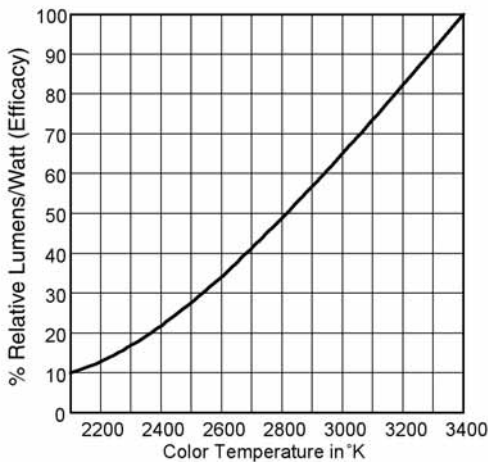

These measurements are characteristics that generally describe how a lamp performs. In some applications, a lamp’s performance must be defined relative to output in a coned area or spot. When this is required, we use a photometer to measure the lamp’s output over a defined area (spot) at a certain distance. This output is normally stated in candlepower or another unit incorporating light per unit area. (Refer to Spot Projection on page 7.)

Color Temperature

Color temperature is a rating used to measure filament temperature, usually in degrees Kelvin (°K). By definition, color temperature is the temperature at which a black body must operate to produce the exact color match of the filament of a lamp. Color temperature can be better understood when relating it to sunlight, which has a nominal color temperature of 5,500°K.

This is an important performance characteristic for a lamp from several significant standpoints. Higher color temperature will give higher energy levels in all wavelength regions of the emission spectrum. As shown in Figure 4 below, a lamp operating at 3,400°K will have nearly three times the relative energy at 400 nanometers and nearly two times the relative energy at 700 nanometers than a lamp operating at 2,800°K.

Figure 4: Color Temperature

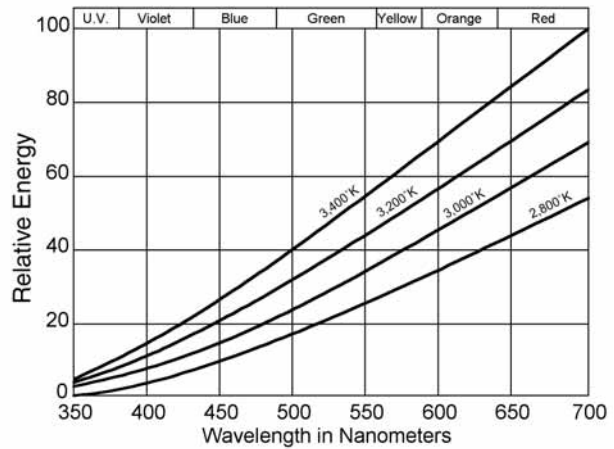

Higher color temperature also contributes to higher luminous efficacy as measured in terms of lumens per watt. Lamps with higher color temperature provide greater efficacy in applications sensitive to near IR (infrared) or IR (heat) and/or power consumption. High color temperature lamps are best in applications utilizing visible light and the human visual response. They offer more light in the green and blue spectral regions, making the light appear whiter. (See Figure 4 above.) In fact, an individual will be able to distinguish all colors better in higher color temperature light.

Typically, a higher color temperature will generally be indicative of shorter lamp life. However, by utilizing Welch Allyn’s experience with lamp design, engineering and production, you will be able to limit and control this trade-off.

MINIATURE HALOGEN LAMPS— ELECTRICAL CHARACTERISTICS

Voltage

HPX lamps are designed to operate from 2 to 28 volts, AC or DC power. Welch Allyn recommends the use of regulated DC power supplies to yield the best life span.

The Rerating Information, shown in Figure 5, shows the relationship of voltage to lamp life. For example, a 10% increase in applied voltage will cause a 70% decrease in lifespan. A 10% decrease in applied voltage will cause lifespan to increase threefold. This clearly shows the value of voltage control and why unregulated AC power supplies are not recommended.

Figure 5: Rerating Information

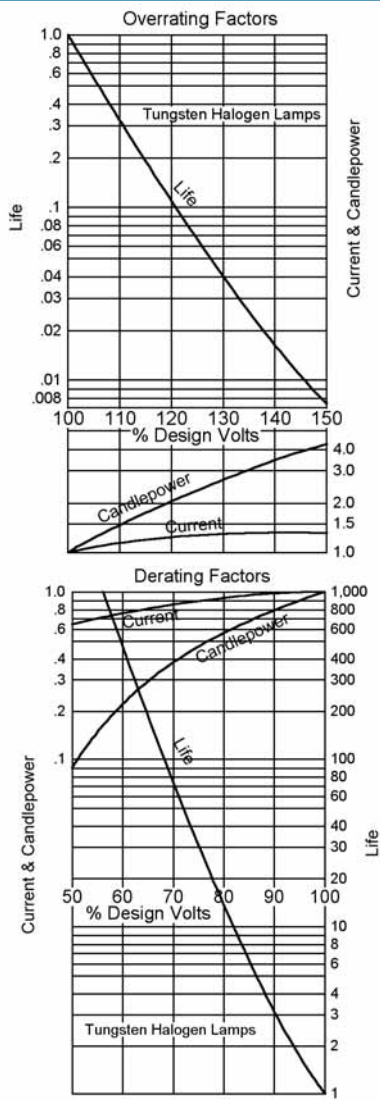

In any application, a lamp may be purposely derated to extend its life as long as light output remains sufficient for the application. We do not recommend derating halogen lamps by more than 10%. There are no restrictions on derating gas-filled or vacuum lamps. If derating a halogen lamp over 10% is one of your requirements, please consult with a Welch Allyn engineer.

Sometimes constant-current sources are used successfully for lamp operation. Actual testing should be done to confirm any and all benefits. A constant-current power source will increase voltage as the filament wire thins. This may cause an apparent premature failure as the lamp is being gradually overvoltaged.

When one of the standard lamps shown in our catalog does not meet your requirements, the lamp may be rerated to produce a new set of specifications. The following three equations can be used for rerating purposes. Factors may be read from Figure 5 and used in the equations, or for more accurate results, the factors may be computed directly.

$$V_d = \text{Design Voltage} \quad V_a = \text{Applied Voltage}$$

$$\text{Rerated Life} = [V_d / V_a]^{12.0} \times \text{Life at Design Voltage}$$

$$\text{Rerated Current} = [V_d / V_a]^{0.55} \times \text{Current at Design Voltage}$$

$$\text{Rerated Candlepower} = [V_d / V_a]^{3.5} \times \text{Candlepower at Design Voltage}$$

These equations serve only as a general rule under ideal conditions. The greater the deviation from the design voltage, the greater the percentage of error in the results from the equations.

Life

The life of a lamp is generally defined as the point at which the lamp fails to light. It is a function of how fast the tungsten evaporates from the filament. This is a result of many factors, such as lamp type, color temperature, duty cycle and end-use qualifications.

This definition does not take into account the degradation of light output over the life of the lamp. If the lamp is still functioning electrically, but not providing the original output, the lamp may have effectively failed.

All Welch Allyn lamps are rated for life based on rack testing at a constant DC voltage until burnout. Actual life may vary depending upon environmental conditions such as thermal shock, vibration, duty cycle or voltage control. The effect of voltage underrating or overrating on lamp life can be estimated according to the Rerating Information shown in Figure 5.

Current Draw

Our standard range of current draw by design is 0.180 amperes to 3.3 amperes. The industry standard for tolerance on current draw is $\pm 10\%$. One way Welch Allyn ensures product precision is to typically control the current draw to within $\pm 5\%$ of the specified current. The Welch Allyn design specification for current draw of $\pm 5\%$ allows us to produce lamps that significantly outperform lamps with wider tolerances.

Lamp output can vary as much as 3% to 4% for each 1% variation in current draw. Figure 6 shows the relationship between current draw tolerance and potential lamp output variation. Tighter specifications are available upon request. Numerous variables must be controlled in design and manufacturing to achieve this.

Figure 6: Current Draw Tolerance Effect

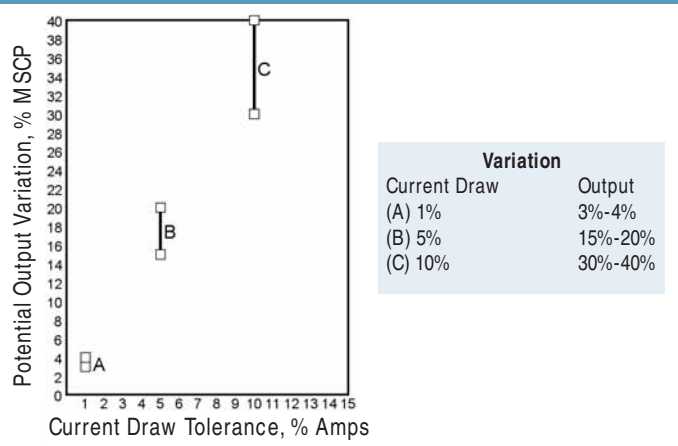

Current draw will vary according to the applied voltage as shown in the Rerating Information in a previous section. Therefore, when the power supply varies in voltage or when the voltage is purposely rerated to alter life or output, the change in current draw must be considered. The wattage (the product of applied voltage times the current draw) also needs to be considered to ensure that the power supply is adequate.

MINIATURE HALOGEN LAMPS—MECHANICAL CHARACTERISTICS

The unique advantage of Welch Allyn lamps can be found in their mechanical design. Each lamp adheres to tight electrical specifications and delivers tight control of light output. In this section, we illustrate the effect that various mechanical design characteristics have on the performance of a lamp in a given application.

Bottom Tip-Off

The tip-off is the area of the envelope where atmospheric air and contaminants are extracted or exhausted from the lamp during manufacture. A secondary process can backfill the lamp with gas, producing the gas-filled lamps and gas-halogen compounds to create the halogen-type lamps described earlier.

Welch Allyn lamps incorporate a bottom tip-off, as shown in Figure 7. A bottom tip-off leaves the top of the lamp clear for an unobstructed view. This gives the user a 270° view of the filament-projected light. The lamp can be viewed from the top or the sides, making it easier to use in precision systems and systems where mounting space may be limited.

Figure 7: Bottom Tip-Off

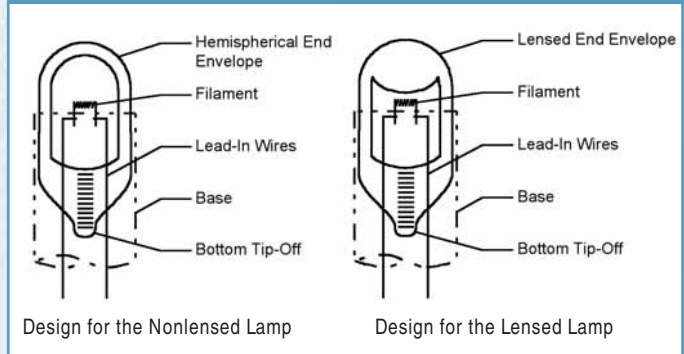

Lensed and Nonlensed Envelopes

For our envelopes, we use a high-temperature optical-grade glass material. There are two basic envelope end configurations: lensed (also referred to as flame-formed) and nonlensed (also referred to as hemispherical).

The lensed-end envelope in Figure 7 will project a well-defined spot—at given distances—from the end of the lamp. The spot can be adjusted and controlled through various means (see Spot Projection in this section). A lensed-end lamp is often used in applications to illuminate a fiber optic bundle, aperture or image plane and where an external lens is not desirable.

The nonlensed envelope in Figure 7 provides an unobstructed view of the filament. This is commonly used in filament imaging applications when external lensing is typically used in the optics.

Spot Projection

The output of a lensed-end lamp can be specified as a spot (diameter) in a plane tangent to the lens and/or a plane perpendicular to the lamp's cylindrical axis, and at a defined distance from the lens as shown in Figure 8. Some applications require a better control of spot size, spot location and output intensity.

Figure 8: Precision Spot Alignment

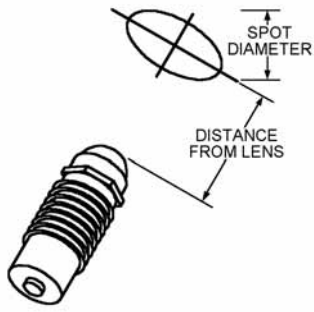

We refer to the combination of these characteristics as spot projection. If required, Welch Allyn can utilize equipment in its manufacturing process to better control spot projection. Lensed-end lamps project a diverging spot often used to illuminate a fiber optic bundle, aperture, image plane or sensor.

Standard lamps which have reasonable spot projection can be used when the system optics are flexible enough to be modified to the lamp's specifications. When the system optics are fixed, a lamp can be designed to provide the spot projection necessary to meet the full requirements of the application.

Precision Optical Basing

In applications where imaging of the filament is important and external optics are used, Welch Allyn can control the filament position by filament optical basing. These applications—including reflectors, projectors and other optical systems—demand that the actual light source (the filament) be on the optical center of the system. Welch Allyn has the capability to place the filament on center to within ± 0.005 " (.127 mm) with respect to the lamp base. We refer to this capability as Precision Optical Basing.

Figure 9: Tolerance on Filament Position (x, y, z)

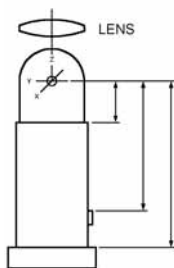

This process provides the necessary mechanical control over the filament placement so as not to compromise the system optics. Better control over the filament position provides a more precise and repeatable system. (See Figure 9.) Filament optical basing also can reduce total lamp replacement costs by minimizing the necessity for adjustment or technical intervention.

Since Welch Allyn's optically based lamps will have an identical filament position, lamp output is repeatable in intensity and position. When this is demanded by the application, Welch Allyn lamps can provide the necessary precision.

MINIATURE HALOGEN LAMPS— ENVIRONMENTAL & OPERATIONAL CONDITIONS

In addition to electrical and mechanical characteristics, environmental and operational conditions can also have an impact on your lamp's performance.

Operating Temperature / Heat Sinking

It is generally thought that all halogen lamps must maintain an envelope temperature of 250°C minimum to ensure operation of the halogen cycle. However, Welch Allyn has developed one of the most efficient halogen gas chemistry in the industry, allowing lamp operation in many applications at temperatures below 250°C. Please note that this is both application and lamp dependent and should be evaluated per application with our design engineers.

The amount of heat generated by a lamp is a direct function of the lamp wattage. A 6 W vacuum lamp will generate as much heat as a 6 W halogen lamp. The only difference may be that the halogen lamp has a smaller envelope and less area to dissipate the heat. Therefore, heat sinking becomes an important factor. You must be certain that the halogen lamp, when properly heat sunk, does not drop below its required operating temperature. Heat sinking does not affect the operation of vacuum or gas-filled lamps. As always, our design engineers are available to assist you.

Shock and Vibration

In all incandescent lamps, the filament becomes brittle as it ages with use. This makes the filament more susceptible to shock and/or vibration, especially when it's cold. If shock or vibration are considered to be potential problems, the lamp should be mechanically isolated. Cold start also needs to be evaluated, since most lamps fail at this time. Soft starts and idle voltage are two ways to reduce these effects. (See In-Rush Current on page 8.)

In-Rush Current

The resistance of the filament (tungsten) wire is significantly less at room temperature than when hot during lamp operation. Therefore, when a lamp is energized, there is an initial current surge, commonly referred to as the in-rush current. This in-rush current may exceed the actual operating or steady-state current by as much as 1000% for several milliseconds. (See Figure 10.) There are design techniques that can be used to control the in-rush current. To learn more, please contact our application engineers for more information.

Figure 10: Typical In-Rush Curve

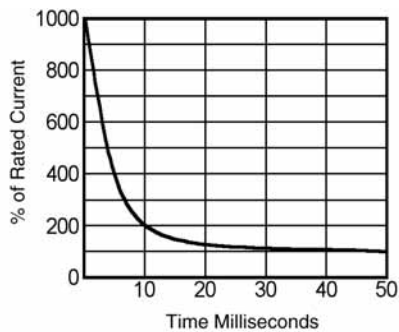

Duty Cycle

The lamp's actual duty (On/Off) cycle can affect its performance. There are no concrete rules establishing the effect of a short On cycle. However, the halogen lamp is the most susceptible to a short duty cycle. Each application should be evaluated in terms of all its requirements, including heat sinking, wattage, in-rush current, etc.

HIGH-IMPACT ILLUMINATION DESIGNED FOR HIGH-PERFORMANCE PRODUCTS

Welch Allyn designs, engineers and manufactures a wide variety of miniature halogen lighting products that are ideal for use in nearly all high-performance lighting systems. Each lamp will provide a highly effective and profitable solution to your illumination needs. Welch Allyn guarantees that each lamp we make will operate according to its specifications under proper operating conditions.

Outstanding Brightness

Welch Allyn lamps can operate at an extremely high color temperature (3,350°K) to provide your customers with pure white illumination and unsurpassed brightness that's consistent over the life of the lamp. What's more, each lamp is made of optical-quality glass, allowing your customers to replace lamps by hand—something that can't be done with quartz.

Durable and Long-Lasting Light

The life of Welch Allyn general-illumination lamps ranges up to 10,000 hours—which is significantly longer than halogen lamps of lesser quality. And when you combine this feature with our superior durability against shock and vibration, you understand the added convenience and value that a Welch Allyn lamp will bring to your product's success.

MINIATURE HALOGEN LAMPS—GENERAL-ILLUMINATION LAMPS, WIRE TERMINALS

The following technical specification tables are the standard wire terminal lamp products offered by Welch Allyn. Our precision lamp design, engineering and manufacturing processes will ensure the desired performance for your critical applications. Should your specifications require a lamp solution not shown in our standard product list, please contact our experienced application engineers.

Figure 11: Wire Terminal Lamps

Lamp P/N	Current (Amps)	Color Temp (°K)	MSCP (Approx)	Envelope Style	Bulb Dia (mm)	Life (Hours)	Gas Type	Spot Size ¹	Filament Size (mm) (L x W)
2.25 Volts									
01270	0.429	2,900	0.43	nl	4.67	650	Krypton		0.610 x 0.229
2.5 Volts									
01265	0.600	3,025	1.00	l	4.67	230	Krypton	3.175	
2.6 Volts									
01098	0.850	3,100	1.63	l	4.67	400	Krypton	3.175	
2.8 Volts									
01080	0.850	3,300	2.63	nl	4.67	15	Halogen		0.762 x 0.254
3.5 Volts									
01264	0.435	2,330	0.47	l	4.67	10,000	Krypton	3.175	
01297	0.575	3,120	1.90	l	4.67	475	Xenon	3.175	
01227	0.720	3,250	2.90	l	3.78	100	Halogen	2.540	
01260	0.720	3,250	2.70	l	4.67	20	Halogen	3.175	
01302	0.740	3,270	3.20	l	3.78	80	Halogen	2.540	
3.65 Volts									
01084	0.980	3,240	4.00	nl	4.67	45	Halogen		0.813 x 0.432
3.7 Volts									
01143	1.020	3,315	5.10	nl	4.67	10	Halogen		0.610 x 0.457
4.0 Volts									
01145	0.750	3,050	3.10	nl	4.67	150	Halogen		0.940 x 0.432
01269	1.200	2,800	3.60	nl	7.10	3,500	Halogen		1.651 x 0.559
4.25 Volts									
01063	0.940	3,050	3.40	l	4.67	150	Halogen	3.175	
4.5 Volts									
01253	0.790	3,250	6.00	nl	4.67	9	Krypton		1.067 x 0.254
01221	1.020	2,825	3.00	nl	6.10	3,900	Halogen		1.829 x 0.559
4.8 Volts									
01119	1.620	3,250	10.70	nl	4.67	22	Halogen		1.473 x 0.508
5.0 Volts									
01163	0.500	3,035	2.77	l	4.67	200	Krypton	3.175	
01300	0.967	2,785	3.80	l	4.67	14,000	Xenon	3.175	
01294	1.000	3,050	4.90	nl	4.67	1,200	Halogen		1.473 x 0.584
01252	1.350	2,800	5.97	l	4.67	1,500	Halogen	3.175	
01296	1.400	2,840	6.00	l	4.67	1,500	Krypton	3.175	
01175	1.435	2,960	7.23	l	4.67	1,500	Halogen	3.175	
5.75 Volts									
01075	1.440	3,335	12.70	l	4.67	35	Halogen	3.175	
6.0 Volts									
01267	0.64	3,050	4.50	nl	4.67	1,000	Xenon		1.981 x 0.254
01293	0.720	3,250	5.75	l	4.67	100	Halogen		
01272	1.690	2,875	9.40	nl	7.10	2,500	Halogen		1.930 x 1.092
01127	1.800	2,920	9.60	l	6.10	1,200	Halogen	5.715	
6.27 Volts									
01152	1.440	3,335	14.70	l	4.67	35	Halogen	3.175	

Envelope Style: l— lensed end; nl— no lens hemispherical end. All dimensions in mm.

¹ Target to lens surface.

Figure 11: Wire Terminal Lamps cont'd

Lamp P/N	Current (Amps)	Color Temp (°K)	MSCP (Approx)	Envelope Style	Bulb Dia (mm)	Life (Hours)	Gas Type	Spot Size ¹	Filament Size (mm) (L x W)
6.3 Volts									
01122	2.000	3,225	22.00	nl	6.10	100	Halogen		1.930 x 0.686
6.5 Volts									
01094	0.430	3,225	3.60	l	4.67	30	Halogen	3.175	
7.25 Volts									
01254	2.050	2,740	11.90	nl	9.91	10,000	Halogen		2.159 x 1.600
8.0 Volts									
01068	2.120	2,950	17.50	nl	9.91	2,500	Halogen		1.930 x 1.575
10.0 Volts									
01291	1.860	2,975	18.40	l	9.91	3,000	Halogen	6.350	
12.0 Volts									
01273	1.670	3,000	25.00	nl	7.10	2,000	Halogen		4.191 x 0.965
14.5 Volts									
01131	2.250	3,300	62.00	nl	9.91	100	Halogen		3.150 x 1.118
15.1 Volts									
01132	2.220	3,245	63.80	nl	9.91	100	Halogen		3.150 x 1.194
28.0 Volts									
01130	0.700	2,950	26.50	nl	9.91	500	Halogen		2.083 x 1.245

Envelope Style: l— lensed end; nl— no lens hemispherical end. All dimensions in mm.

¹Target to lens surface.

Figure 12: Standard Based Lamps

Lamp P/N	Current (Amps)	Color Temp (°K)	MSCP (Approx)	Envelope Style	Bulb Dia (mm)	Life (Hours)	Gas Type	Wire Terminal P/N	Base Config (Figure 23)	Spot Size ¹	Filament Size (L x W)	Optical Based (OB) vs. Spot Aligned (SA)
2.5 Volts												
997418-3	0.366	2,800	0.45	l	4.67	1,200	Krypton	01128	M	2.540		SA
2.6 Volts												
998087-8	0.850	2,840	0.95	l	4.67	3,000	Halogen	01058	H	3.175		
998418-5	0.850	2,840	0.95	l	4.67	3,000	Halogen	01058	M	3.175		
3.5 Volts												
998087-1	0.720	3,250	2.70	l	4.67	20	Halogen	01107	K	3.175		
998418-1	0.720	3,250	2.70	l	4.67	20	Halogen	01107	M	3.175		
4.0 Volts												
998418-6	1.200	2,865	3.80	l	4.67	1,500	Halogen	01129	M	3.175		SA
4.5 Volts												
998085-3	0.890	2,800	2.45	nl	6.10	1,000	Halogen	01019	E		1.753 x 0.533	OB
5.0 Volts												
998319-21	1.500	2,840	5.15	l	7.11	4,000	Halogen	01077	G	5.715		
998319-15	1.790	2,915	7.20	l	7.11	6,000	Halogen	01059	G	5.715		
998085-10	1.790	2,915	7.20	l	7.11	6,000	Halogen	01059	E	5.715		
998319-13	2.080	2,900	7.90	nl	7.11	5,000	Halogen	01074	F		1.600 x 1.041	
6.0 Volts												
998085-4	0.700	3,050	3.75	nl	7.11	2,000	Halogen	01070	E		1.575 x 0.686	
8.0 Volts												
998319-16	1.190	2,850	7.80	l	7.11	2,500	Halogen	01069	G	5.715		
10.0 Volts												
998080-1	1.780	3,050	22.15	l	9.91	500	Halogen	01006	D	6.350		
998079-12	1.780	3,050	22.15	nl	9.91	500	Halogen	01010			2.489 x 1.016	OB
998079-14	1.860	2,950	17.70	l	9.91	3,000	Halogen	01012		6.350		

MINIATURE HALOGEN LAMPS—GENERAL-ILLUMINATION LAMPS, BASED LAMPS

The technical specifications table (Figure 23 on page 21) shows the standard based lamp products offered by Welch Allyn. Our precision lamp design, engineering and manufacturing processes will ensure the desired performance for your critical applications. Should your specifications require a lamp solution not shown in our standard product list, please contact our experienced application engineers.

MINIATURE HALOGEN LAMPS—REFLECTORIZED LAMP TYPES, PARABOLIC & ELLIPTICAL

The technical specification tables (Figures 13 & 14) are the standard reflectorized lamp products offered by Welch Allyn. Our precision lamp design, engineering and manufacturing processes will ensure the desired performance for your critical applications. Should your specifications require a lamp solution not shown in our standard product list, please contact our experienced application engineers.

Optical system performance often depends on elements beyond the lamp itself. The right reflector can increase the optical system efficiency by 300% to 500%. With more than 30 years of miniature optical system experience, Welch Allyn offers a full line of metal and glass reflectors to complement our precision lamps. Design and performance advantages include:

- MR-3 to MR-11 sizes: 9.5 mm (0.375 inches) to 35.1 mm (1.38 inches)
- Precise lamp alignment within the reflector for optimum performance
- Complete advanced testing for output and spot size based on your requirements
- Single and multiple surface designs



Welch Allyn's subminiature reflectorized lamp assemblies are specifically designed for applications where optical system performance, reliability and durability are critical. Welch Allyn reflectorized lamps are used in various products in the following markets:

- Flashlights/Torches
- Chemical and Clinical Analysis
- Medical and Dental Instrumentation
- Fiber Optic Illumination
- Machine Vision
- Microscope Illumination
- Industrial Safety Headlamps

Our design and application engineers can assist you in selecting the appropriate lamp and reflector for your specifications and invite you to contact us for your custom design requests.

Elliptical Specifications

Figure 13: Elliptical Reflector Lamps

Lamp P/N	Amps	Color Temp (°K)	Life (Hours)	Reflector Size	Spot Size ¹ (mm)	Lux @ F2 Using Aperture Diameter of		Focal Distance (mm)	Lamp Type
						1.27 mm	2.5 mm		
3.00 Volts									
7104-006	0.500	3,240	20	MR4	1.27	3,766	–	12.7	Gas
7106-006	0.500	3,240	20	MR6	1.52	4,304	–	19.1	Gas
3.50 Volts									
7103-001	0.575	3,120	250	MR3	3.30	1,345	–	12.7	Gas
7104-001	0.935	3,085	300	MR4	2.03	4,035	–	12.7	Gas
7104-004	0.575	3,050	400	MR4	1.78	2,044	–	12.7	Gas
7106-001	0.935	3,085	300	MR6	2.54	5,843	–	19.1	Gas
7106-004	0.575	3,050	400	MR6	2.54	2,260	–	19.1	Gas
3.65 Volts									
8103-002	0.980	3,240	45	MR3	3.81	3,701	–	12.7	Halogen
4.25 Volts									
8104-002	1.060	3,000	650	MR4	2.79	3,131	–	12.7	Halogen
8106-002	1.060	3,000	650	MR6	3.30	4,336	–	19.1	Halogen
5.00 Volts									
7103-002	0.970	2,800	10,000	MR3	4.57	1,173	–	12.7	Gas
7104-002	0.970	2,800	10,000	MR4	3.81	1,894	–	12.7	Gas
7106-003	0.970	2,800	10,000	MR6	3.56	2,755	–	19.1	Gas
8208-004	2.000	2,880	5,000	MR8	6.10	–	9,038	25.4	Halogen
6.27 Volts									
8103-001	1.440	3,335	60	MR3	4.57	2,152	–	12.7	Halogen
8104-001	1.440	3,335	60	MR4	3.05	8,393	–	12.7	Halogen
8106-001	1.440	3,335	60	MR6	3.30	11,944	–	19.1	Halogen
12.0 Volts									
8211-002	1.670	3,000	2,000	MR11	6.60	–	17,754	35.6	Halogen
8211-005	1.000	3,280	40	MR11	5.59	–	19,906	35.6	Halogen
8211-007	1.170	3,120	200	MR11	5.59	–	19,906	35.6	Halogen
14.0 Volts									
8211-001	1.790	3,200	200	MR11	6.60	–	25,663	35.6	Halogen

All dimensions in mm. 1 inch = 25.4 mm. Output is in Lux: Footcandles = Lux ÷ 10.76

¹ Target to lens surface.

Table of Numerical Apertures for Elliptical Reflectors

MR3	.35
MR4	.40
MR6	.42
MR8	.39
MR11	.38

Numerical Aperture (NA): The sine of the half angle of the light rays that will be accepted by a fiber optic bundle. The NA of the lamp should be less than or equal to the NA of the fiber optic bundle.

Parabolic Specifications

Figure 14: Parabolic Reflector Lamps

Lamp P/N	Amps	Color Temp (°K)	Life (Hours)	Reflector Size	Divergence Angle ± 2°	Minimum Required Distance from Reflector Rim to Target (mm)	Lux Measured from a Distance of		Lamp Type
							0.9 mm	1.22 mm	
3.00 Volts									
7104-005	0.500	3,240	20	M R4	4	360	484	–	Gas
7106-005	0.500	3,240	20	M R6	4	360	1280	–	Gas
4.25 Volts									
8104-003	1.060	3,000	650	M R4	9	180	334	–	Halogen
8106-003	1.060	3,000	650	M R6	7	180	968	–	Halogen
5.00 Volts									
7104-003	0.970	2,800	10,000	M R4	7	180	226	–	Gas
7106-002	0.970	2,800	10,000	M R6	7	125	592	–	Gas
8208-005	2.00	2,880	5,000	M R8	10	305	–	538	
12.00 Volts									
8211-003	1.000	3,280	40	M R11	6	305	–	1,323	Halogen
8208-002	1.000	3,280	40	M R8	6	305	–	1,065	Halogen
8211-006	1.170	3,120	200	M R11	6	305	–	1,323	Halogen
8208-001	1.670	3,000	2,000	M R8	9	305	–	1,216	Halogen
8211-004	1.670	3,000	2,000	M R11	9	305	–	1,506	Halogen
14.00 Volts									
8208-003	1.790	3,200	200	M R8	9	305	–	2,152	Halogen

All dimensions in mm. 1 inch = 25.4 mm. Output is in Lux: Footcandles = Lux ÷ 10.76

¹Target to lens surface.

Notes

- Life is the average number of hours until a lamp reaches end of life, which is signified by burnout.
- Halogen lamps must be run with minimum heat sinking for optimum halogen cycle.
- Sockets are available to facilitate operation of the reflectorized lamps. For more information contact our applications engineers.
- Although halogen lamps should be run with minimum heat sinking for optimum halogen cycle, heat sinking is required so that the reflector neck temperatures of 105°C are not exceeded in lamps using plastic sockets.

Parabolic Terms and Characteristics Explained

Elliptical reflectorized lamps deliver high-intensity light efficiently into small apertures or fiber optic bundles.

Figure 15: Parabolic Reflector

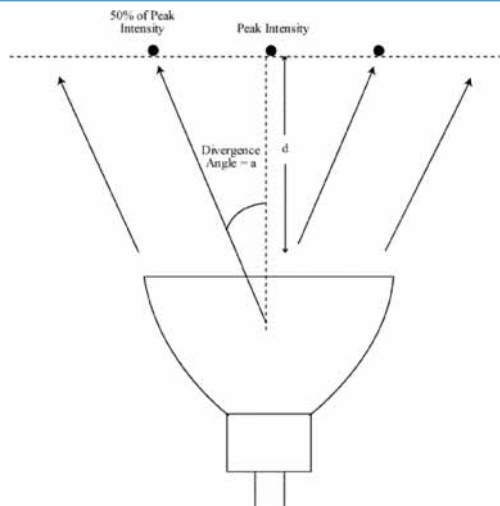

Parabolic reflectorized lamps are designed with various beam divergence angles, which are measured at the 50% intensity points.

Minimum Distance Required from Reflector Rim to Target: Because the reflectors are true parabolic shapes, the hole in the back of the reflector is imaged at the center of the projected spot at distances less than the specified distance required between the reflector rim and the target.

Spot Diameter = $2 \times (d \times \tan(a/2))$ as defined in the diagram.

Figure 16: Parabolic Spot

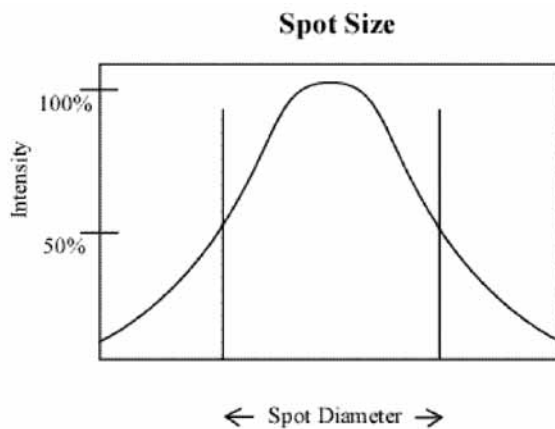

For parabolic reflectors spot size is the diameter determined by the edge of the spot having 50% of the center peak intensity.

Elliptical Terms and Characteristics Explained

Elliptical reflectorized lamps deliver high-intensity light efficiently into small apertures or fiber optic bundles.

Figure 17: Elliptical Reflector

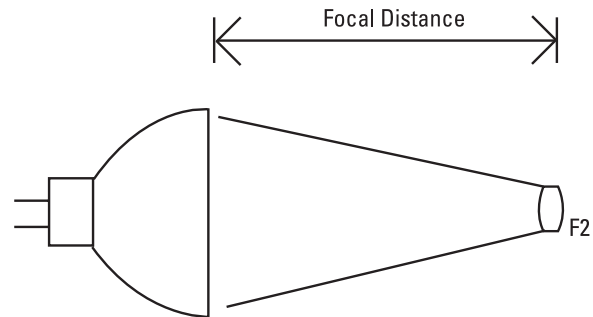

Focal Distance in elliptical reflectors is measured from the rim of the reflector to the F2 spot location.

F2: The secondary focal point of an ellipse.

Figure 18: Large Filament Elliptical Lamp

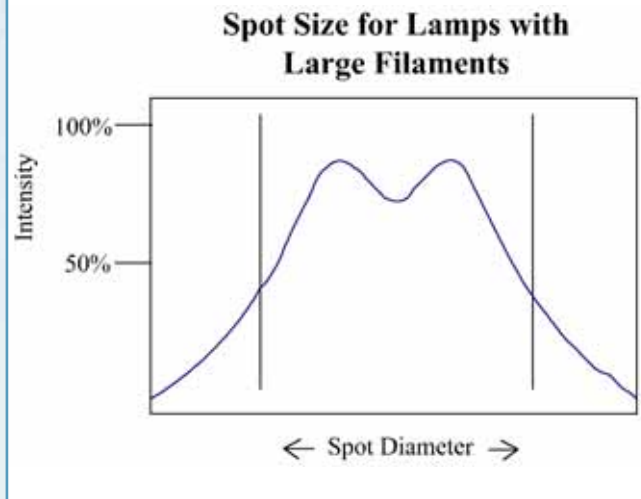

In elliptical reflectorized lamps with large filaments, large spots are produced. In these cases the projected spot is not a point peak. When focused correctly, the spot produced is an oblong shape with two peaks as shown in Figure 18.

Lamps with large filaments may have spots that are more oval in shape. In these cases the measured spot diameter is always the narrower diameter.

NOTE:

The projected spot from some elliptical reflectors may visually appear to be somewhat off center with the axis of the reflector. However, they are assembled to provide the specified lux through an aperture on axis at the F2 location. When used with a fiber optic bundle, care must be taken to match the optical properties of the fiber with the lamp.

MR Reflector Dimensions in Millimeters (Inches)

Our MR reflectors are aluminum and come with a metallic coating. Each unit of MR is equal to 3.175 mm (.125 inches)
MR3 = 3 x (3.175 mm).

Figure 19: MR Reflector Dimensions

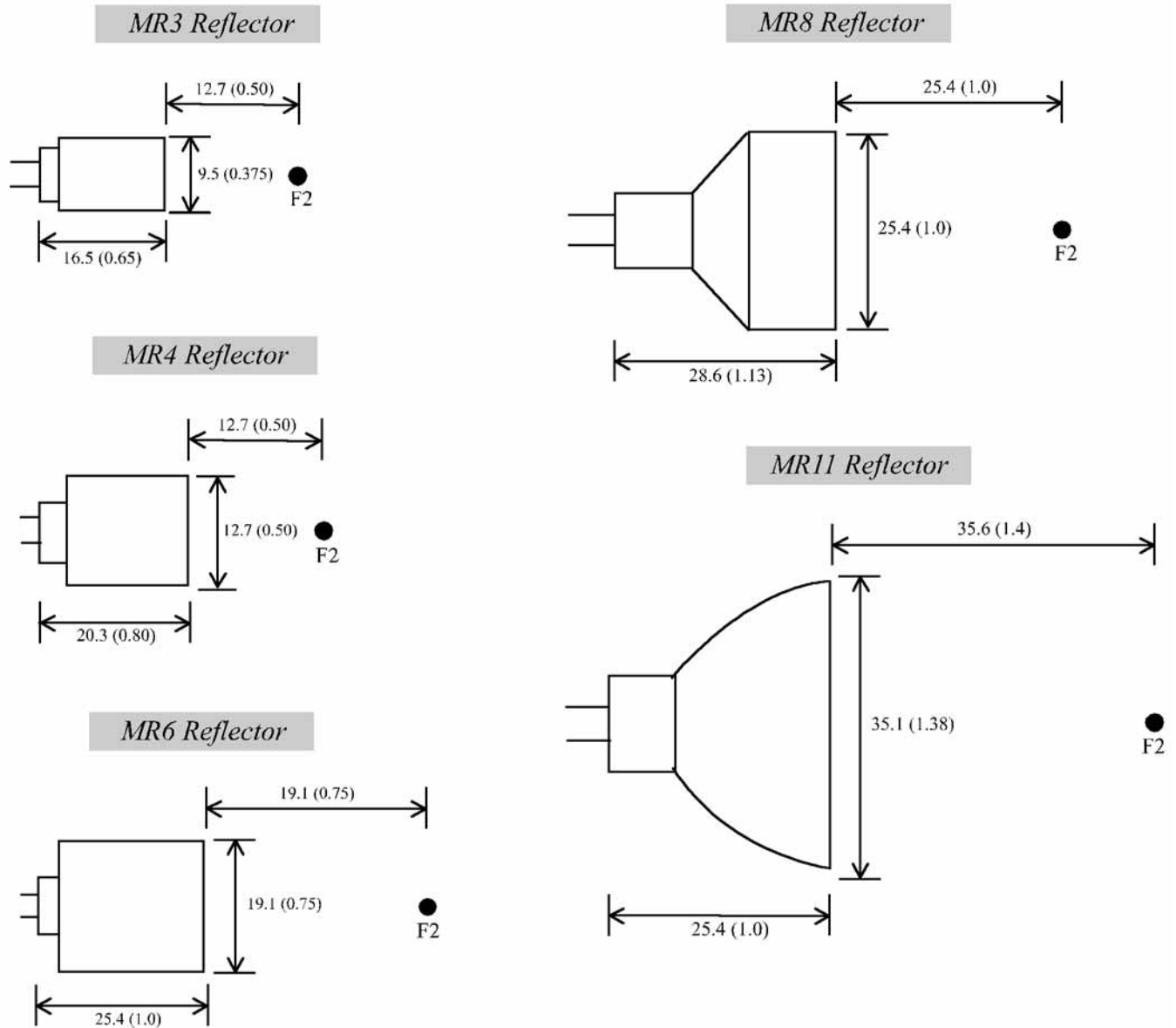

F2 Applies to Elliptical Reflectors ONLY

Glass MR-11 Reflectors with dichroic coating are available upon request. Consult factory.

HALOGEN LAMPS—APPLICATION NOTES, ENHANCED UV MINIATURE LAMPS

Halogen Lamps AD L9501 Miniature Lamps

Welch Allyn has developed a unique technology for the manufacture of hard glass, tungsten halogen lamps which maintains all the advantages of glass construction while significantly enhancing the UV output. At 340 nm, for instance, the lamps have greater than 89% of the output of a quartz-enveloped lamp of similar wattage. The lamps may be applied in the range of 240 nm through visible light.

The construction of the lamps offers numerous advantages to the designers of analytical instruments and other precision lamp users. The lamps are tipped-off at the bottom, which permits a 270° end view of the projected light or the possibility of forming a lens at the distal end of the lamp. The lensed-end lamps provide accurate, definable spot projection. The nonlensed-end lamps allow precision filament positioning for external lens configurations.

Like all Welch Allyn lamps, the lamps can be precision based, which can drastically reduce the support cost of replacement lamps for instrumentation. The lighting system designer, who can take advantage of the optical precision of the lamps, can often produce an end product with substantially reduced size and weight.

Spectral Distribution

Normally, the output of miniature glass lamps will begin to fall off steeply below 400 nm. The construction of our new Enhanced UV Miniature Lamps allows much higher UV outputs. In the past, instrumentation designers often had to use higher power quartz lamps to provide adequate UV for the measurement. Now they can take advantage of the inherent precision of a hard glass lamp to achieve better focus, easier replacement, and frequently, a smaller instrument. Refer to Figure 20a.

Design and performance advantages of Welch Allyn's UV enhanced lamps include:

- No "tip-off" to prevent end-on use
- Elimination of foil seals allows substantial size reductions
- Precision basing allows precision optics, simplifies replacement and can allow lower wattage for lower power/ lower heating
- Lamp is not affected by handling

Figure 20a: Spectral Output: Enhanced UV Lamps

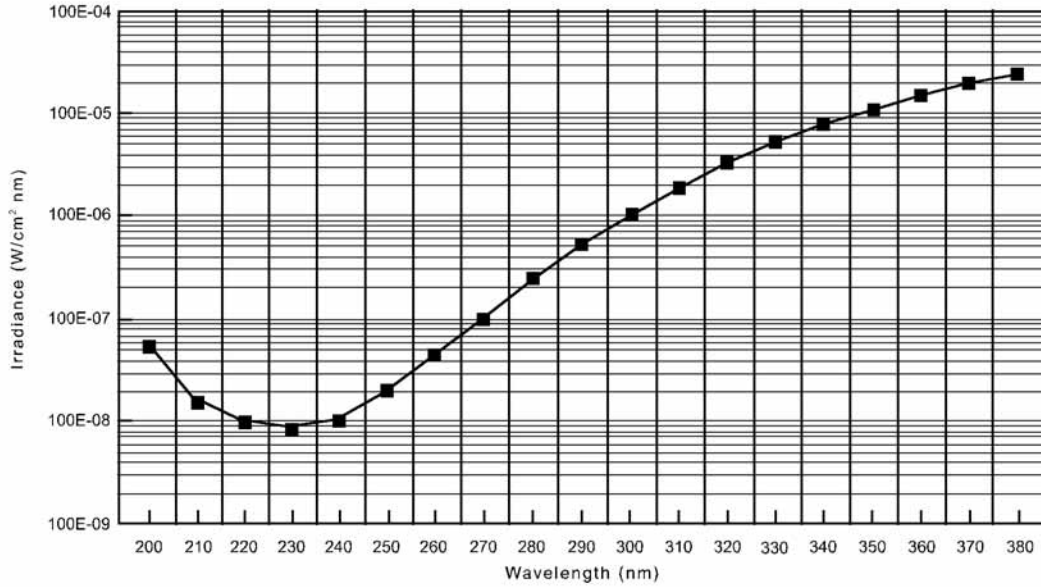
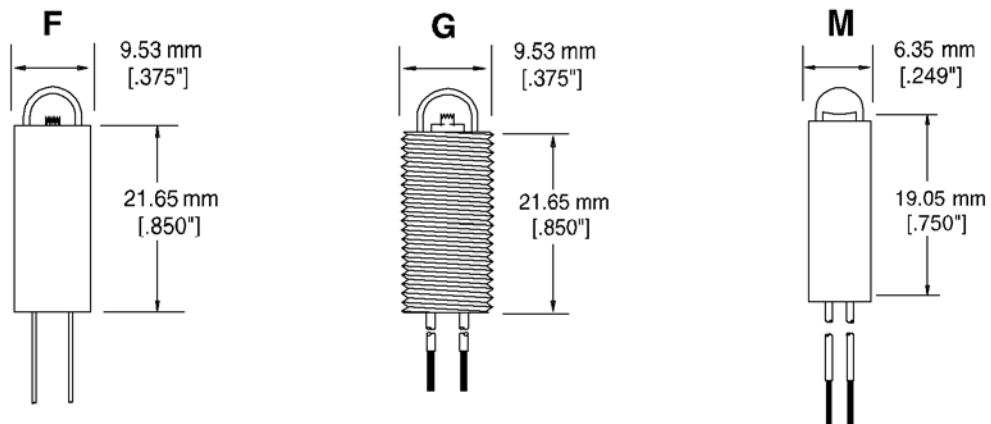

Figure 20b: Specifications

	Low Power Subminiature	Medium Power Miniature
Bulb Diameters	0.184" (4.67 mm)	0.280" (7.1 mm)
Base Diameters	0.250" (6.35 mm)	0.375" (9.53 mm)
Wattage Range	1–9 Watts	5–30 Watts
Voltage Range	3.5–7.5 Volts	5.0–12.0 Volts
Current Range	0.7–1.5 Amps	1.0–2.0 Amps
Color Temperature	2,800–3,300°K	
Average Life	200–10,000 Hours	
Typical Light Maintenance	>80% Initial Output @ 70% of Average Life	

Figure 20c: Base Configurations



MEDICAL & DENTAL INSTRUMENTS

Lighting the Way to Better Healthcare

During the 1960s, Welch Allyn pioneered the development of miniature lamps in medical and dental diagnostic instruments. Since then, we've continuously improved the design, engineering and manufacture of each lamp to meet the specific demands of the medical and dental industries: consistent, precise illumination and superior durability.

Today, Welch Allyn lamps are used worldwide in many types of diagnostic instruments from direct-illuminating ophthalmoscopes and otoscopes to advanced video endoscopes and imaging systems. Now you can bring this same unequalled performance to your medical and dental products.

Precise Spot Illumination

The lamp filament in each of our miniature halogen lamps is guaranteed to be on center with the lamp's base to within 0.50mm. For medical and dental applications, we also offer our optical "Precision Optical Basing" manufacturing technique. Precision Optical Basing will also help ensure the performance of Welch Allyn lamps in instruments with fixed external lenses. This allows your customers to replace lamps whenever needed—without having to recalibrate the lighting system. More importantly, they'll be spared costly service calls and downtime for repairs.

Medical and Dental Expertise

More than any other lamps manufacturer, Welch Allyn understands the unique operating conditions that medical and dental instruments must endure. That's why every Welch Allyn miniature halogen lamp is built to withstand the shock and vibration that many medical or dental instruments experience every day.

What's more, Welch Allyn miniature halogen lamps are built to last hundreds of hours longer than competitive lamps. This gives your product—and your customers—the benefit and security of consistent, dependable light output for longer than ever before.

MINIATURE HALOGEN LAMPS—MEDICAL & DENTAL INSTRUMENT LAMPS

The following technical specification table shows the standard medical and dental lamp products offered by Welch Allyn. (See Figure 21 below.) Our precision lamp design, engineering and manufacturing processes will ensure the desired performance for your critical applications. Should your specifications require a lamp solution not shown in our standard product list, please contact our experienced application engineers.

Figure 21: Medical & Dental Instrument Lamps

Lamp P/N	Current (Amps)	Color Temp (°K)	MSCP (Approx)	Envelope Style	Bulb Dia (mm)	Life (Hours)	Gas Type	Base Config (Fig 23)	Spot Size ¹	Filament Size (L x W)	Optical Based (OB) vs. Spot Aligned (SA)
2.6 Volts											
998087-8	0.85	2,840	0.95	I	4.67	3000	Halogen	H	3.175		
3.5 Volts											
998070-1	0.72	3,250	2.9	I	3.785	100	Halogen	T	2.54		
998070-8	0.74	3,050	3.2	I	3.785	60	Halogen-Xenon		2.54		
998087-1	0.72	3,250	2.7	I	4.67	20	Halogen	K	3.175		
998087-17	0.73	3,250	2.89	nl	4.67	14	Halogen			0.889 x 0.254	OB
01302	0.74	3,270	3.2	I	3.785	80	Halogen-Xenon		2.54		
01227	0.72	3,250	2.9	I	3.785	100	Halogen-Xenon		2.54		
01346	0.74	3,050	3.2	I	3.785	60	Halogen-Xenon		2.54		
01348	0.74	3,270	3.2	I	3.785	60	Halogen-Xenon		2.54		
998070-6	0.69	3,280	2.8	I	3.785	35	Halogen-Xenon		2.54		
6.0 Volts											
998087-24	0.72	3,250	5.75	I	4.67	100	Halogen	T	3.175		

Envelope Style: I—lensed end; nl—no lens hemispherical end. All dimensions in mm.

¹ Target to lens surface.

ANALYTICAL INSTRUMENTS

When Precision Analysis Demands Precision Lighting

Given the importance of light in analytical instruments like blood analyzers or spectrophotometers, the success of your product's design is dependent on your choice of lighting system. Welch Allyn's superior lighting technology provides your products with the precise illumination you'll need to deliver accurate, reliable results your customers demand.

Engineered for Exact Focus

Welch Allyn's "Precision Optical Basing" option guarantees that the filament in each lamp will be on center with the lamps base to within .127 mm. This means that the lamp will project its light exactly where it is needed. More importantly, the lighting system will not have to be adjusted to work with the system's external lenses. This ensures dependable performance from every lamp. Furthermore, Welch Allyn's lensed-end lamps may reduce the need for additional optics entirely.

Ease of Installation

Another benefit of "Precision Optical Basing" can be realized when a lamp is replaced. Because the lamp's filament is guaranteed to be in its ideal position in relation to the lamp base, you can also be sure that the lamp will operate efficiently with all fixed lenses and optics within the analytical instrument. This allows the user to replace a lamp—whenever needed—without having to readjust the optics to account for a lesser quality lamp.

What's more, Welch Allyn miniature halogen lamps are made of optical-quality glass. This means users can handle our lamps with their bare hands, without risking damage to the lamp—a common problem with sensitive quartz lamps.

MINIATURE HALOGEN LAMPS

Analytical Instrument Lamps

The following technical specification table shows the standard analytical instrument lamp products offered by Welch Allyn. (See Figure 22.) Our precision lamp design, engineering and manufacturing processes will ensure the desired performance for your critical applications.

Should your specifications require a lamp solution not listed in our standard product list, please contact our experienced application engineers.

Figure 22: Analytical Instrument Miniature Halogen Lamps

Lamp P/N	Current (Amps)	Color Temp (°K)	MSCP (Approx)	Envelope Style	Bulb Dia (mm)	Life (Hours)	Gas Type	Base Config (Fig 23)	Spot Size ¹	Filament Size (L x W)	Optical Based (OB) vs. Spot Aligned (SA)
2.5 Volts											
997418-3	0.366	2,800	0.45	I	4.670	1,200	Krypton	M	2.540		SA
2.6 Volts											
998087-8	0.850	2,840	0.95	I	4.670	3,000	Halogen	H	3.175		
3.5 Volts											
997418-16	0.435	2,330	0.47	I	4.674	10,000	Krypton	M	3.175		
997418-19	0.575	3,120	1.90	I	4.674	475	Xenon	M	3.175		
998418-1	0.720	3,250	2.70	I	4.670	20	Halogen	M	3.175		
4.0 Volts											
998418-6	1.200	2,865	3.80	I	4.670	1,500	Halogen	M	3.175		SA
5.0 Volts											
998418-12	1.350	2,800	5.97	I	4.670	1,500	Halogen	M	3.175		OB
998418-13	1.000	3,050	4.90	nl	4.670	1,200	Halogen	M		1.473 x 0.584	OB
997418-18	1.400	2,840	6.00	I	4.670	1,500	Krypton	M	3.175		OB
998319-21	1.500	2,840	5.15	I	7.110	5,000	Halogen	G	5.715		
998319-15	1.790	2,915	7.20	I	7.110	6,000	Halogen	G	5.715		
998319-13	2.080	2,900	7.90	I	7.110	5,000	Halogen	F		1.600 x 1.041	
8.0 Volts											
998319-16	1.190	2,850	7.80	I	7.110	2,500	Halogen	G	5.715		
10.0 Volts											
998079-28	1.860	2,975	18.40	I	9.906	3,000	Halogen		6.350		
12.0 Volts											
998319-35	1.670	3,000	25.00	nl	7.112	2,000	Halogen	F		4.191 x 0.965	OB

Envelope Style: I—lensed end; nl—no lens hemispherical end. All dimensions in mm.

¹Target to lens surface.

MINIATURE HALOGEN LAMPS—LAMP BASE

All Welch Allyn miniature halogen lamps can be supplied with various base configurations. The following are the standard lamp base configurations that are readily available.

Should your specifications require a lamp solution not listed in our standard products list, please contact our experienced application engineers.

Figure 23: Lamp Base and Socket Configurations

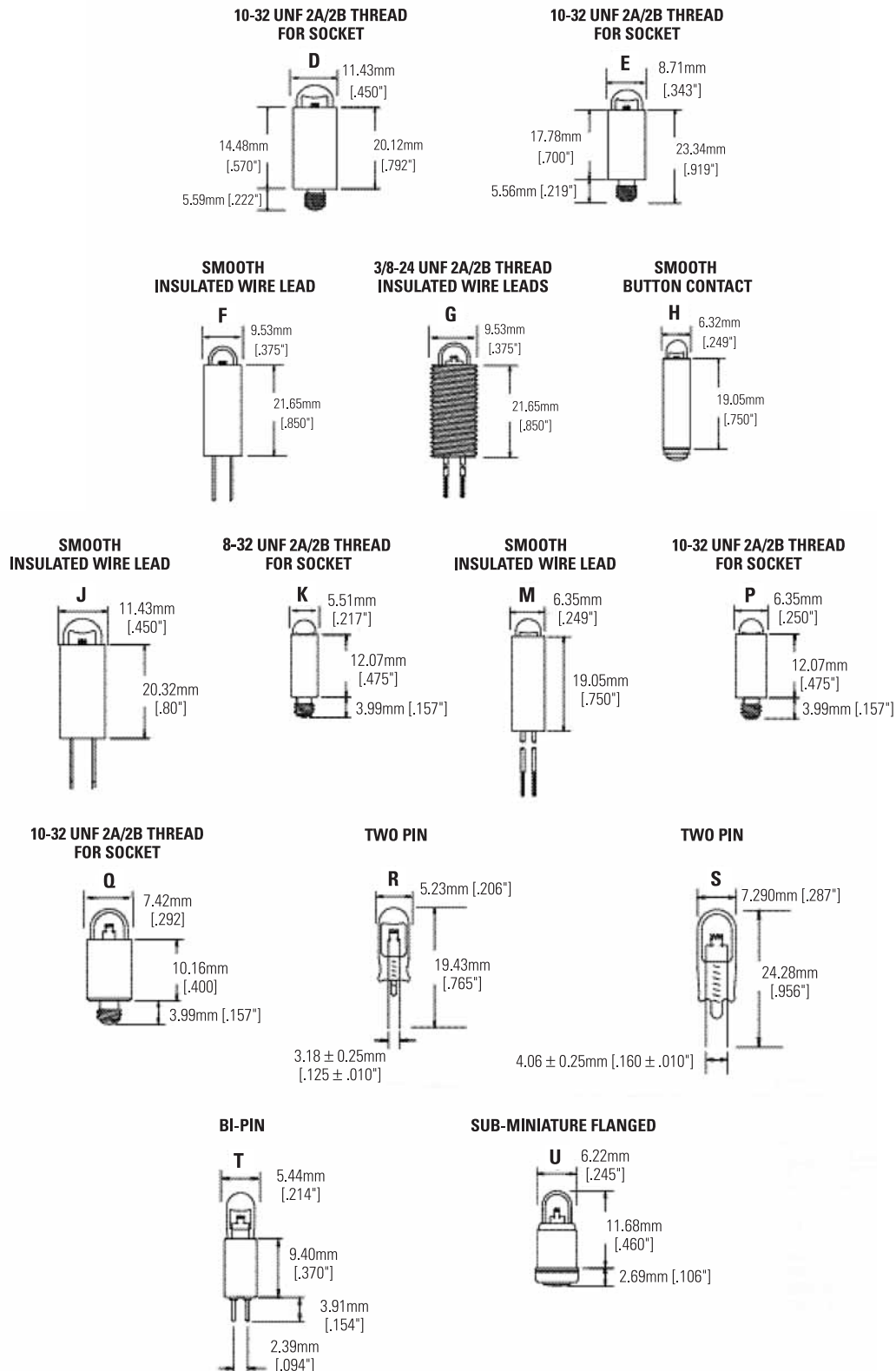

Welch Allyn—Your Source For
Precision Arc & Halogen Lamps



Please Note: Continuous product improvement requires we reserve the right to change these specifications without notice.
© 2006 Welch Allyn MC3544 Rev B Printed in U.S.A.

4619 Jordan Road
Skaneateles Falls, NY 13153-0187
Phone: 315.685.4347
Fax: 315.685.2854
www.walamp.com