

### KEY FEATURES

- Pulsable Sources of Black-Body Radiation
- Emulates a Black-Body in Spectral Distribution
- Ultra-Thin Metallic Foil Active Element
- Parabolic Reflectors for Collimation and Uniformity
- Typical Emissivity 0.88

### Pulsable Infrared Emitters - SVF Series

Opto Diode SVF Series infrared (IR) emitters are designed to be used as pulsable sources of black-body radiation.

The radiating element in the pulsable emitters is an ultra-thin Opto Diode specific metallic foil configured so that radiation from both sides of the heated foil is efficiently directed out of the package along the optic axis. The foil material has typical emissivity of 0.88 and closely emulates a black-body source in spectral distribution. SVF Series emitters are designed to operate at a rated maximum foil temperature of 1000 K.

Standard SVF Series emitters are offered in sealed TO-5 or TO-8 packages in a variety of foil thickness and width.

Several standard window materials are available to tailor the output to specific wavelength ranges of interest.

SVF Series emitters are offered with an integral reflector. Standard parabolic reflectors provide near collimated and uniform radiation output. A variety of elliptical reflectors with varying focal lengths are also available for coupling into optical fibers or other applications.

### Drive Circuit

Switching device like the IRF350, a 400 V single N-channel MOSFET with, very low on-state resistance combined with high transconductance, superior reverse energy and diode recovery  $dv/dt$  capability is suitable.

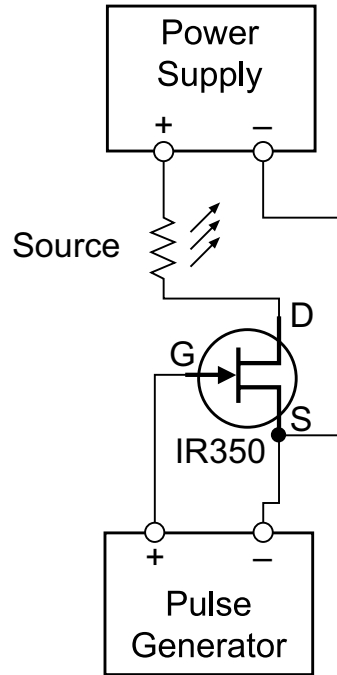

### Lifetime

All standard emitters have mean times to failure (MTBF) greater than 30,000 hours at the maximum rated power input. Operation of the element above this input power may significantly reduce the lifetime.

**Black-Body Radiant Emittance**

SVF Series emitters approximate black-body sources at their particular operating temperature. Below is a reference graph showing ideal black-body curves at various temperatures, in K.

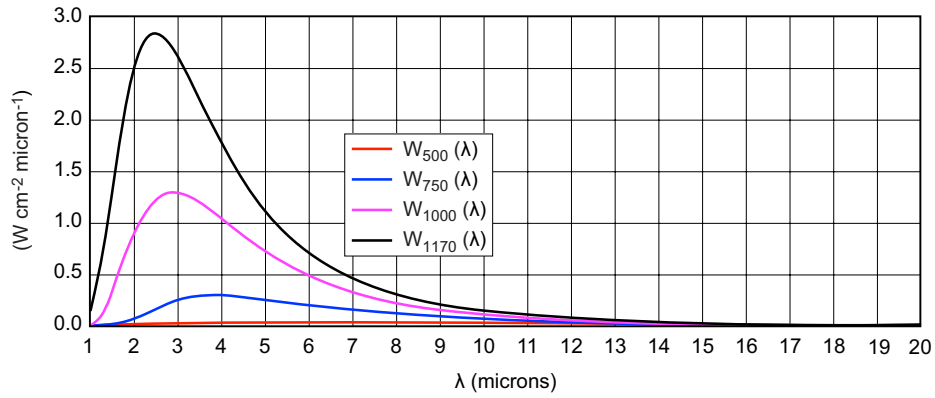

## SVF Series TO-5

### DC Power Curves (I vs. V)<sup>1</sup>

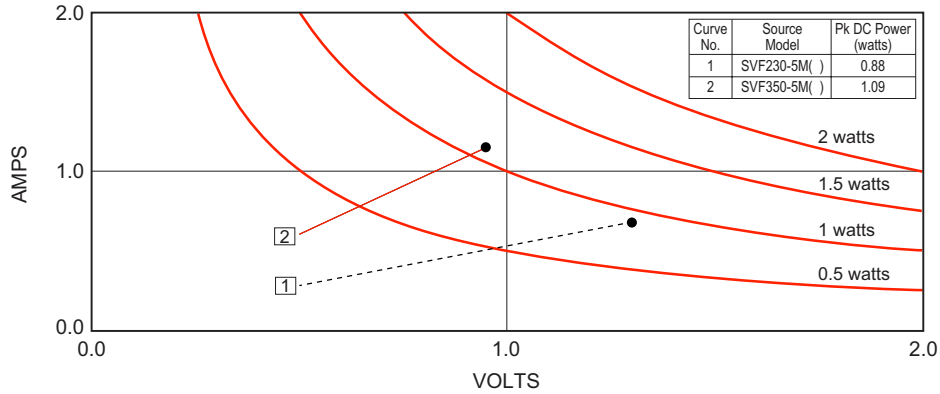

<sup>1</sup> 1000 K at power indicated, exceeding this value will raise element temperature and decrease source lifetime.

### Modulation Depth vs. Frequency

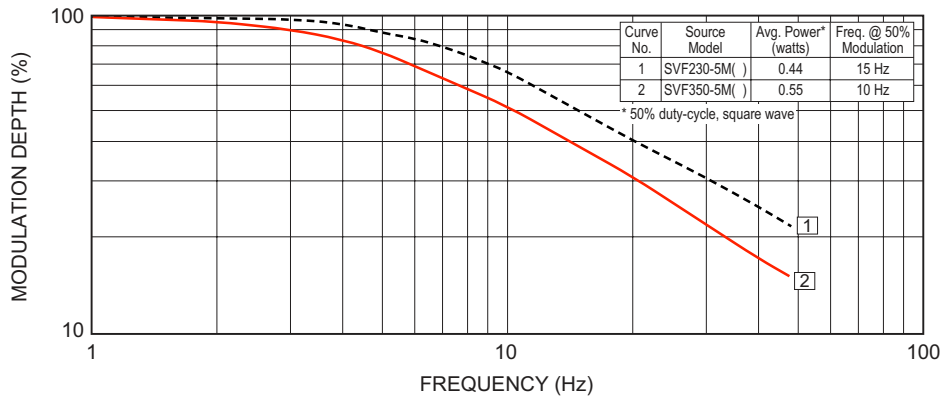

### Average DC Intensity<sup>2</sup> (@ 1000°K) vs. Angle (@ 3 inches)

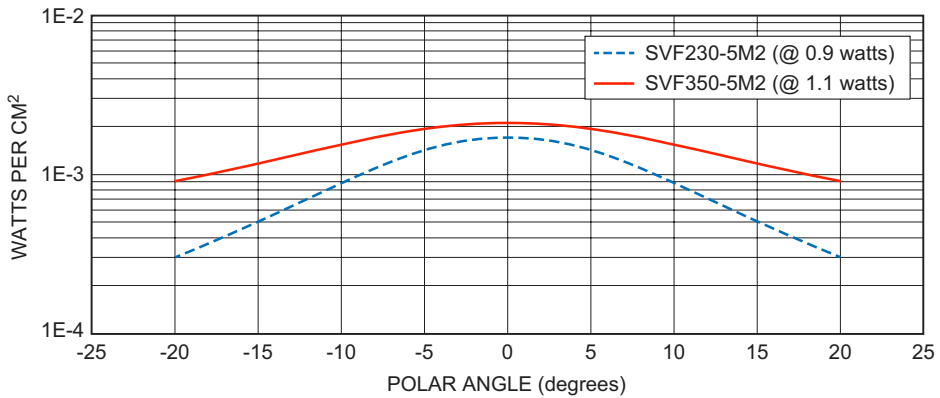

<sup>2</sup> Average of values parallel and perpendicular to axis of element.

## DC Intensity (@ 1000 K) vs. Distance

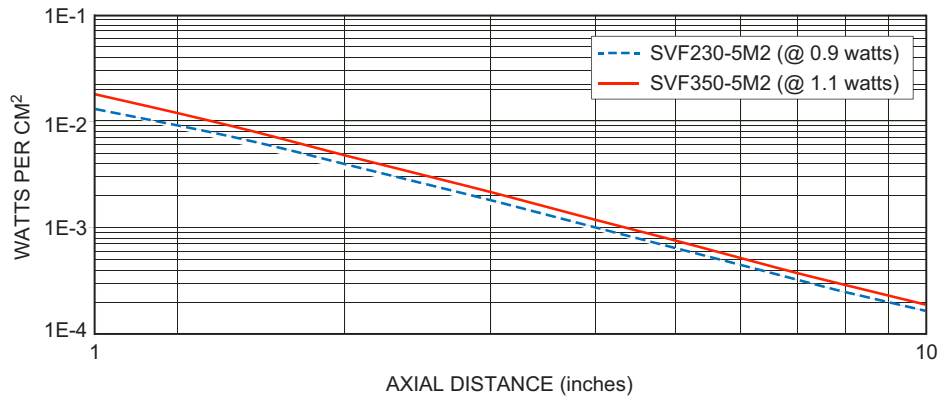

**SVF Series TO-8**

**DC Power Curves (I vs. V)<sup>3</sup>**

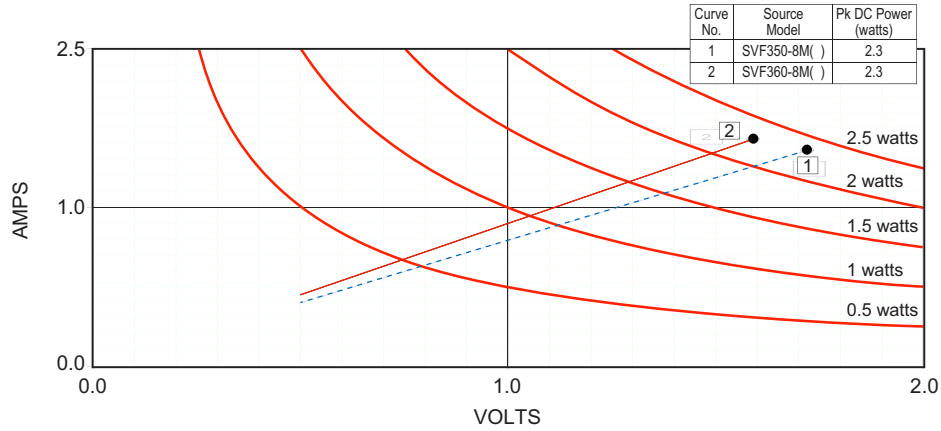

<sup>3</sup> 1000 K at power indicated, exceeding this value will raise element temperature and decrease source lifetime.

**Modulation Depth vs. Frequency**

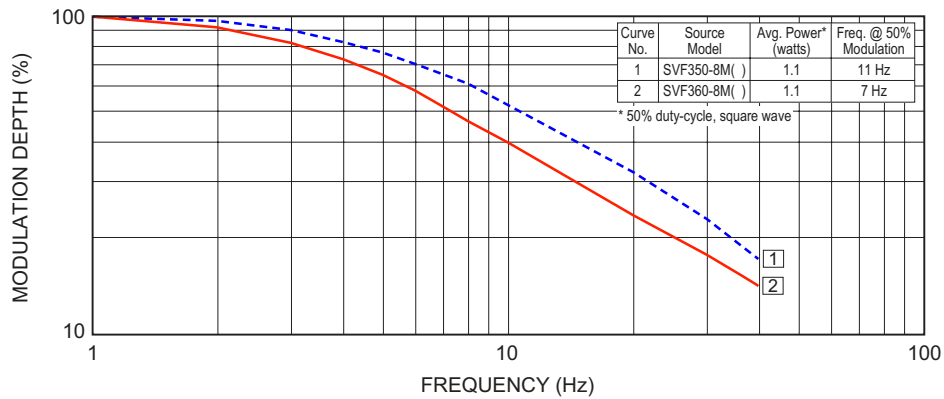

**Average DC Intensity<sup>4</sup> (@ 1000 K) vs. Angle (@ 3 inches)**

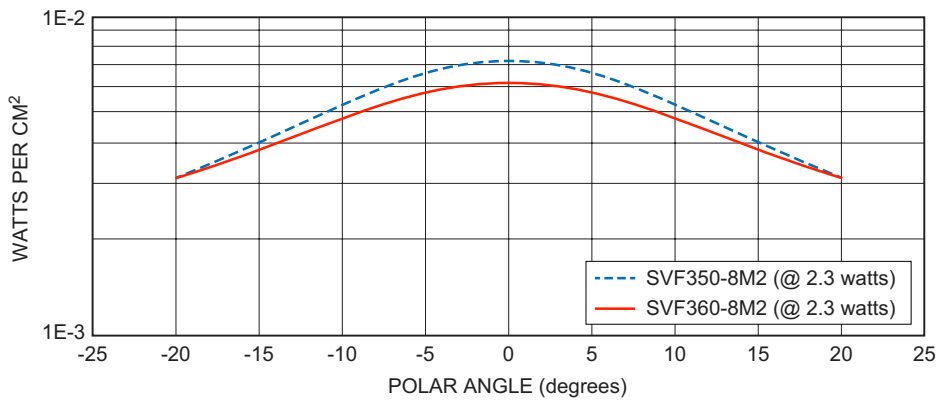

<sup>4</sup> Average of values parallel and perpendicular to axis of element.

**DC Intensity (@ 1000 K) vs. Distance**

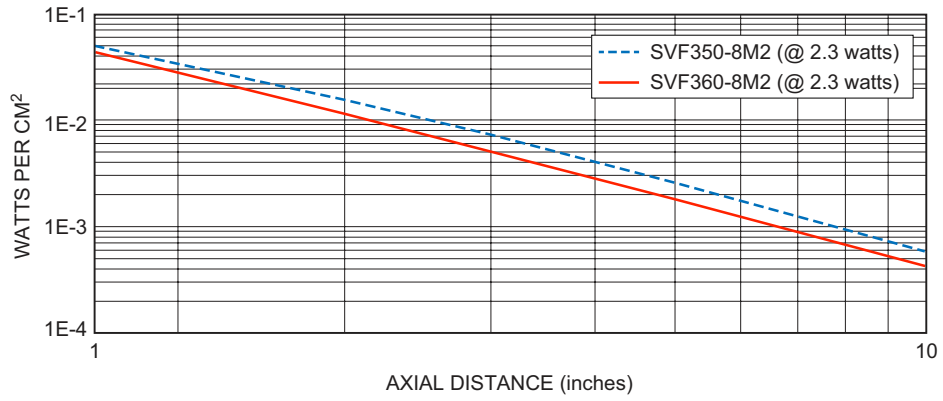

**TO-5 Package**

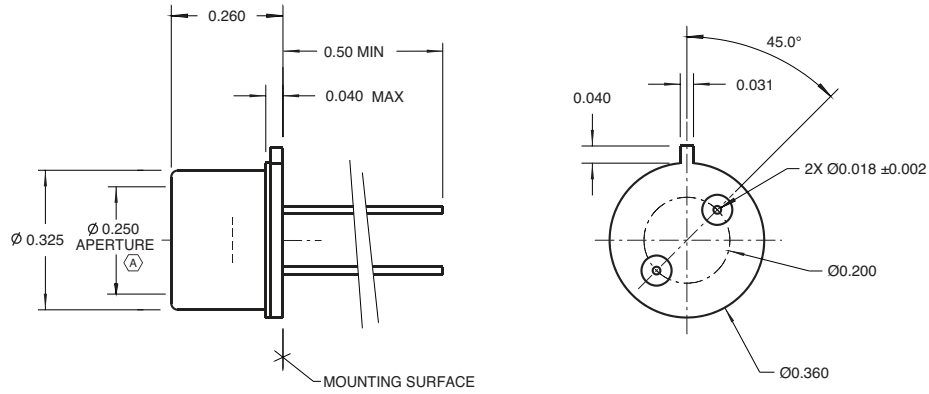

**TO-8 Package**

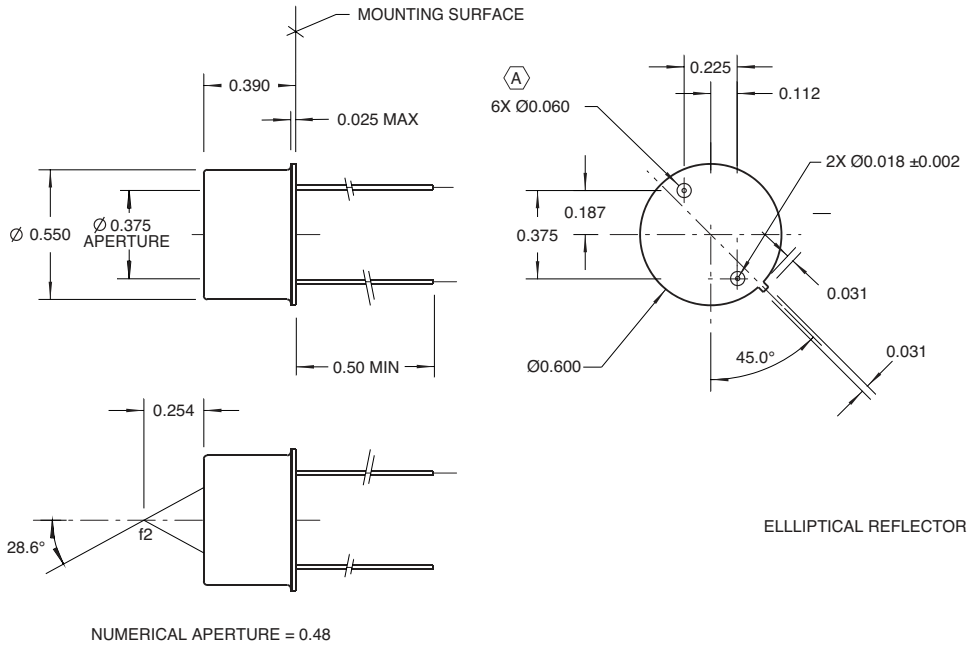



**Window Spectral Transmission Options**

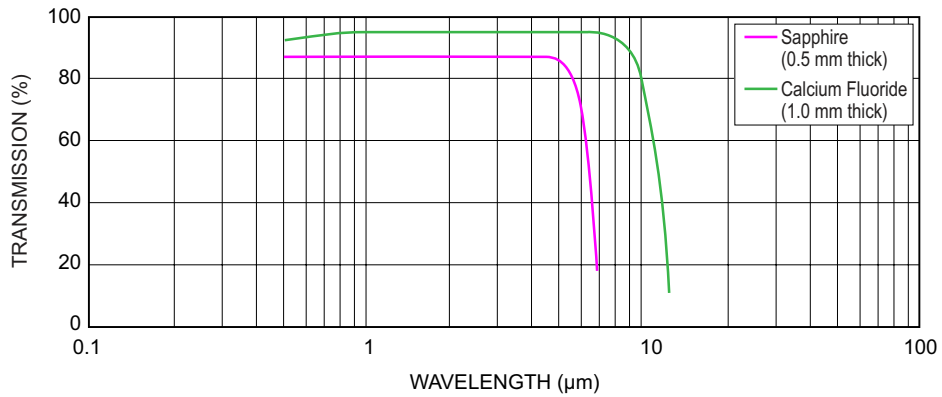

**Ordering Information**

SVF-XXXXX-YYY

SVF – S Source, VF Pulsable

XXXXX – Filament and Foil Dimensions

YYY – Packaging Options and Window Options

**SVF230-5M2 (40103)** Standard Pulsable Emitter 230 in TO5 Package with Sapphire Window

**SVF350-5M2 (40106)** Standard Pulsable Emitter 350 in TO5 Package with Sapphire Window

**SVF360-8M2 (40432)** Standard Pulsable Emitter 360 in TO8 Package with Sapphire Window

**SVF230-5M3 (40104)** Standard Pulsable Emitter 230 in TO5 Package with Calcium Fluoride Window

**SVF350-5M3 (40107)** Standard Pulsable Emitter 350 in TO5 Package with Calcium Fluoride Window

**SVF350-8M3 (40172)** Standard Pulsable Emitter 350 in TO8 Package with Calcium Fluoride Window

**SVF360-8M3 (40110)** Standard Pulsable Emitter 360 in TO8 Package with Calcium Fluoride Window

Specifications are subject to change without prior notice.